



QuantaGrid Series

D52B-1U

**Full-Featured Energy Efficient 2-Way Server
User's Guide**

Copyright

Copyright © 2017 Quanta Computer Inc. This publication, including all photographs, illustrations and software, is protected under international copyright laws, with all rights reserved. Neither this guide, nor any of the material contained herein, may be reproduced without the express written consent of the manufacturer. All trademarks and logos are copyrights of their respective owners.

Version 1.0 / November 10, 2017

Disclaimer

The information in this document is subject to change without notice. The manufacturer makes no representations or warranties with respect to the contents hereof and specifically disclaims any implied warranties of merchantability or fitness for any particular purpose. Furthermore, the manufacturer reserves the right to revise this publication and to make changes from time to time in the content hereof without obligation of the manufacturer to notify any person of such revision or changes.

For the latest information and updates please see www.QCT.io

All the illustrations in this guide are for reference only and are subject to change without prior notice.

TABLE OF CONTENT

About the System

Introduction	1-1
System Features.....	1-1
SKU information	1-4
Package Contents	1-7
A Tour of the System	1-8
System Overview	1-8
System Front View.....	1-10
Front Control Panel (FCP).....	1-11
System Rear View	1-12
System Rear I/O	1-12
Power Sub-System	1-13
HDD / M.2 Adapter Configuration.....	1-14
Full 2.5" HDD Configuration	1-14
Hybrid 3.5"+2.5" HDD Configuration.....	1-15
NVMe SSD M.2 Adapter Add-On Card (Optional)	1-15
Enabling the Intel® VMD technology.....	1-16
Spanning RAID data volumes across VMD domains.....	1-18
LED Status Definitions	1-21
Front Control Panel LEDs.....	1-21
BMC Management Port LEDs	1-22
Storage Drive LED.....	1-22
Enabling Platform Trusted Technology (PTT)	1-24
TPM configuration settings	1-24

Regulatory and Compliance Information

Conventions

Several different typographic conventions are used throughout this manual. Refer to the following examples for common usage.

Bold type face denotes menu items, buttons and application names.

Italic type face denotes references to other sections, and the names of the folders, menus, programs, and files.

<Enter> type face denotes keyboard keys.



WARNING!

Warning information appears before the text it references and should not be ignored as the content may prevent damage to the device.



CAUTION!

CAUTIONS APPEAR BEFORE THE TEXT IT REFERENCES, SIMILAR TO NOTES AND WARNINGS. CAUTIONS, HOWEVER, APPEAR IN CAPITAL LETTERS AND CONTAIN VITAL HEALTH AND SAFETY INFORMATION.

Note:

Highlights general or useful information and tips.

Precautionary Measures

Read all caution and safety statements in this document before performing any of the instructions. To reduce the risk of bodily injury, electrical shock, fire, and equipment damage, read and observe all warnings and precautions in this chapter before installing or maintaining your system. To avoid personal injury or property damage, before you begin installing the product, read, observe, and adhere to all of the following instructions and information. The following symbols may be used throughout this guide and may be marked on the product and / or the product packaging.

Safety Instructions about your system

In the event of a conflict between the information in this guide and information provided with the product or on the website for a particular product, the product documentation takes precedence.

Your system should be integrated and serviced only by technically qualified persons.

You must adhere to the guidelines in this guide and the assembly instructions in related chapters to ensure and maintain compliance with existing product certifications and approvals. Use only the described, regulated components specified in this guide. Use of other products / components will void the UL Listing and other regulatory approvals of the product, and may result in noncompliance with product regulations in the region(s) in which the product is sold.

Table 1: Warning and Cautions





CAUTION	Indicates the presence of a hazard that may cause minor personal injury or property damage if the CAUTION is ignored.
WARNING	Indicates the presence of a hazard that may result in serious personal injury if the WARNING is ignored.
	Indicates potential hazard if indicated information is ignored.
	Indicates shock hazards that result in serious injury or death if safety instructions are not followed.
	Indicates hot components or surfaces.
	Indicates do not touch fan blades, may result in injury.
	Remove the system from the rack to disconnect power system.

Table 1: Warning and Cautions (Continued)

	The enclosure is designed to carry only the weight of the system sled. Do not use this equipment as a workspace. Do not place additional load onto any equipment in this system.
	Indicates two people are required to safely handle the system.

Intended Application Uses

This product was evaluated as Information Technology Equipment (ITE), which may be installed in offices, schools, computer rooms, and similar commercial type locations. The suitability of this product for other product categories and environments (such as medical, industrial, residential, alarm systems, and test equipment), other than an ITE application, may require further evaluation.

Site Selection

The system is designed to operate in a typical office environment. Choose a site that is:

- Clean, dry, and free of airborne particles (other than normal room dust).
- Well-ventilated and away from sources of heat including direct sunlight and radiators.
- Away from sources of vibration or physical shock.
- Isolated from strong electromagnetic fields produced by electrical devices.
- In regions that are susceptible to electrical storms, we recommend you plug your system into a surge suppressor and disconnect telecommunication lines to your modem during an electrical storm.
- Provided with a properly grounded wall outlet.
- Provided with sufficient space to access the power system, because they serve as the product's main power disconnect.
- Provided with either two independent DC power system or two independent phases from a single power system.

Equipment Handling Practices

Reduce the risk of personal injury or equipment damage:

- Conform to local occupational health and safety requirements when moving and lifting equipment.
- Use mechanical assistance or other suitable assistance when moving and lifting equipment.

- To reduce the weight for easier handling, remove any easily detachable components.
- Never lift or move your system solely by the handle on the component.

Power and Electrical Warnings



CAUTION!

MAKE SURE THE SYSTEM IS REMOVED FROM THE RACK BEFORE SERVICING ANY NON-HOT PLUG COMPONENTS. THE BUS BAR CLIPS MUST BE DISCONNECTED FROM THE POWER SYSTEM IN ORDER TO FULLY SEPARATE THE SYSTEM FROM THE POWER SOURCE.



CAUTION!

TO AVOID RISK OF ELECTRIC SHOCK, DISCONNECT ALL CABLING FROM THE SYSTEM AND REMOVE THE SYSTEM FROM THE RACK.

System Access Warnings



CAUTION!

TO AVOID PERSONAL INJURY OR PROPERTY DAMAGE, THE FOLLOWING SAFETY INSTRUCTIONS APPLY WHENEVER ACCESSING THE INSIDE OF THE PRODUCT:

- Disconnect from the power source by removing the system from the rack.
- Disconnect all cabling running into the system.
- Retain all screws or other fasteners when servicing. Upon completion servicing, secure with original screws or fasteners.



CAUTION!

IF THE SERVER HAS BEEN RUNNING, ANY INSTALLED HDD MODULES MAY BE HOT.



CAUTION!

UNLESS YOU ARE ADDING OR REMOVING A HOT-PLUG COMPONENT, ALLOW THE SYSTEM TO COOL BEFORE SERVICING.



CAUTION!

TO AVOID INJURY DO NOT CONTACT MOVING FAN BLADES. IF YOUR SYSTEM IS SUPPLIED WITH A GUARD OVER THE FAN, DO NOT OPERATE THE SYSTEM WITHOUT THE FAN GUARD IN PLACE.

Rack Mount Warnings

The following installation guidelines are required by UL for maintaining safety compliance when installing your system into a rack.

The equipment rack must be anchored to an unmovable support to prevent it from tipping when your system or piece of equipment is extended from it. The equipment rack must be installed according to the rack manufacturer's instructions.

Install equipment in the rack from the bottom up, with the heaviest equipment at the bottom of the rack.

Extend only one piece of equipment from the rack at a time.

You are responsible for installing a main power disconnect for the entire rack unit. This main disconnect must be readily accessible, and it must be labeled as controlling power to the entire unit, not just to the system(s).

To avoid risk of potential electric shock, a proper safety ground must be implemented for the rack and each piece of equipment installed in it.

Elevated Operating Ambient - If installed in a closed or multi-unit rack assembly, the operating ambient temperature of the rack environment may be greater than room ambient. Therefore, consideration should be given to installing the equipment in an environment compatible with the maximum ambient temperature (T_{ma}) specified by the manufacturer.

Reduced Air Flow - Installation of the equipment in a rack should be such that the amount of air flow required for safe operation of the equipment is not compromised.

Mechanical Loading - Mounting of the equipment in the rack should be such that a hazardous condition is not achieved due to uneven mechanical loading.

Circuit Overloading - Consideration should be given to the connection of the equipment to the supply circuit and the effect that overloading of the circuits might have on over-current protection and supply wiring. Appropriate consideration of equipment nameplate ratings should be used when addressing this concern.

Reliable Earthing - Reliable earthing of rack-mounted equipment should be maintained.

Particular attention should be given to supply connections other than direct connections to the branch circuit (e.g. use of power strips).

Electrostatic Discharge (ESD)



CAUTION!

ESD CAN DAMAGE DRIVES, BOARDS, AND OTHER PARTS. WE RECOMMEND THAT YOU PERFORM ALL PROCEDURES AT AN ESD WORKSTATION. IF ONE IS NOT AVAILABLE, PROVIDE SOME ESD PROTECTION BY WEARING AN ANTI-STATIC WRIST STRAP ATTACHED TO CHASSIS GROUND -- ANY UNPAINTED METAL SURFACE -- ON YOUR SERVER WHEN HANDLING PARTS.

Always handle boards carefully. They can be extremely sensitive to ESD. Hold boards only by their edges without any component and pin touching. After removing a board from its protective wrapper or from the system, place the board component side up on a grounded, static free surface. Use a conductive foam pad if available but not the board wrapper. Do not slide board over any surface.

Cooling and Airflow



CAUTION!

CAREFULLY ROUTE CABLES AS DIRECTED TO MINIMIZE AIRFLOW BLOCKAGE AND COOLING PROBLEMS. FOR PROPER COOLING AND AIRFLOW, OPERATE THE SYSTEM ONLY WITH THE CHASSIS COVERS* / AIR DUCT INSTALLED. OPERATING THE SYSTEM WITHOUT THE COVERS / AIR DUCT IN PLACE CAN DAMAGE SYSTEM PARTS . TO INSTALL THE COVERS* / AIR DUCT:

- Check first to make sure you have not left loose tools or parts inside the system.
- Check that cables, add-in cards, and other components are properly installed.

Attach the covers* / air duct to the chassis according to the product instructions.

* May not apply to all systems.

Please be aware that slots and openings on the front and rear side of the chassis are designed for ventilation; to make sure reliable operation of your system and to protect it from overheating, these openings must not be covered or blocked. The openings should never be covered or blocked by placing the product on a bed, sofa, rug, or other similar surface. This product should never be placed near or over a radiator or heat register, or in a built-in installation unless proper ventilation is provided.

Laser Peripherals or Devices



CAUTION!

TO AVOID RISK OF RADIATION EXPOSURE AND / OR PERSONAL INJURY:

- Do not open the enclosure of any laser peripheral or device.
- Laser peripherals or devices are not serviceable.
- Return to manufacturer for servicing.

Use certified and rated Laser Class I for Optical Transceiver product.

Heed safety instructions: Before working with the system, whether using this manual or any other resource as a reference, pay close attention to the safety instructions. Adhere to the assembly instructions in this manual to ensure and maintain compliance with existing product certifications and approvals. Use only the described, regulated components specified in this manual. Use of other products / components will void the UL listing and other regulatory approvals of the product and will most likely result in non-compliance with product regulations in the region(s) in which the product is sold.

System power on/off: To remove power from system, you must remove the system from rack. Make sure the system is removed from the rack before opening the chassis, adding, or removing any non hot-plug components.

Hazardous conditions, devices and cables: Hazardous electrical conditions may be present on power, telephone, and communication cables. Turn off the system and disconnect the cables attached to the system before opening it. Otherwise, personal injury or equipment damage can result.

Electrostatic discharge (ESD) and ESD protection: ESD can damage drives, boards, and other parts. We recommend that you perform all procedures in this chapter only at an ESD

workstation. If one is not available, provide some ESD protection by wearing an antistatic wrist strap attached to chassis ground any unpainted metal surface on the server when handling parts.



ESD and handling boards: Always handle boards carefully. They can be extremely sensitive to electrostatic discharge (ESD). Hold boards only by their edges. After removing a board from its protective wrapper or from the server, place the board component side up on a grounded, static free surface. Use a conductive foam pad if available but not the board wrapper. Do not slide board over any surface.

Installing or removing jumpers: A jumper is a small plastic encased conductor that slips over two jumper pins. Some jumpers have a small tab on top that can be gripped with fingertips or with a pair of fine needle nosed pliers. If the jumpers do not have such a tab, take care when using needle nosed pliers to remove or install a jumper; grip the narrow sides of the jumper with the pliers, never the wide sides. Gripping the wide sides can damage the contacts inside the jumper, causing intermittent problems with the function controlled by that jumper. Take care to grip with, but not squeeze, the pliers or other tool used to remove a jumper, or the pins on the board may bend or break.

General Information

Before servicing this system, it is recommended to read this guide completely to be aware of any safety issues or requirements involved in the servicing of this system.

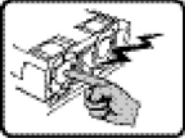
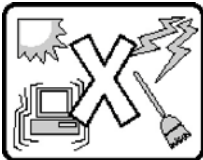
Assembly Safety Guidelines

	<p>The power system in this product contains no user-serviceable parts. Refer servicing only to qualified personnel.</p>
	<p>The system is designed to operate in a typical office environment. Choose a site that is:</p> <ul style="list-style-type: none"> ● Clean and free of airborne particles (other than normal room dust). ● Well ventilated and away from sources of heat including direct sunlight. ● Away from sources of vibration or physical shock. ● Isolated from strong electromagnetic fields produced by electrical devices. ● In regions that are susceptible to electrical storms, we recommend you plug your system into a surge suppressor and disconnect telecommunication lines to your modem during an electrical storm. ● Provided with a properly grounded wall outlet. ● Provided with sufficient space to access the power system, because they serve as the product's main power disconnect.
	<p>WARNING!</p> <p>The system is safety certified as rack-mounted equipment for use in a server room or computer room, using an approved customer rack. The enclosure is designed to carry only the weight of the system sled. Do not place additional load onto any equipment.</p>



Heavy object. Indicates two people are required to safely handle the system.

Structure of this guide

- Chapter 1: About the System
“This section introduces the system, its different configuration(s) and the main features.”
- Chapter 2: Regulatory and Compliance Information
“This section provides regulatory and compliance information applicable to this system.”

About the System

Chapter 1

This section introduces the system, its different configuration(s) and the main features.

1.1 Introduction

This document provides an overview of the hardware features of the chassis, troubleshooting information, and instructions on how to add and replace components of the server.

For the latest version of this manual, see www.QCT.io.

System Features

The system comprises a 1U/30.7" long chassis. Major features include:

- **Chipset:** Intel® C621 / C624
 - **Processors (x2):** Intel® Xeon® Processor Scalable Family (codename Skylake-SP)
 - **Expansion:** See *SKU information on page 1-4* for more information.
 - **Memory:** Up to 24 DIMM slots are available; ECC DDR4 2666 MT/s RDIMM memory
 - **Network*:**
 - Dedicated GbE management NIC port from PHY RTL8211 to BMC
 - Intel® C621 as 2x or 4x GbE integrated network solution with PHY (optional)*
 - Intel® C624 as 2x or 4x 10GbE integrated network solution with PHY (optional)*
- *The dual port or quad port PHY card is installed to OCP mezzanine slot*

*Visit www.QCT.io for the latest Network support listings.

Note:

The system supports: 500W and 800W Titanium/Platinum redundant PSU, 100-240VAC 50/60Hz, AC/ HVDC; 1100W redundant DC PSU: Acbe I/P: DC -39 - - 72v, 37A max.

Specifications

Table 1.1: System Specifications

SPECIFICATIONS	DESCRIPTION
Form factor	1U rack mount
Chassis dimensions (W x H x D)	440mm x 43.2 mm x 780 mm 17.3" x 1.7" x 30.7"
Processor	<p>Processor type: Intel® Xeon® Processor Scalable Family (codename Skylake-SP)</p> <p>Max. TDP support: 165W, Optimized power delivery for 85W, VRD 13</p> <p>Number of processors: 2</p> <p>Internal Interconnect: 10.4 GT/s, 9.6 GT/s</p>

Table 1.1: System Specifications (Continued)

SPECIFICATIONS	DESCRIPTION																																		
Chipset	Intel® C621 / C624																																		
Memory	<p>Total slots: 24</p> <p>Memory type: DDR4 2666 MT/s RDIMM</p> <p>Memory size: 8GB, 16GB, 32 GB*</p> <p>*More options refer to the AVL</p>																																		
Storage controller	<p>Onboard (Intel® C621 / C624):</p> <ul style="list-style-type: none"> (8) SATA 6Gbps port with (2) mini-SAS HD connector (6) sSATA 6Gbps port with (1) mini-SAS HD connector (reserved) and (2) 7-pin SATA port (reserved for SATA DOM) 																																		
Networking	<ul style="list-style-type: none"> Dedicated GbE management NIC port from PHY RTL8211 to BMC Intel® C621 as 2x or 4x GbE integrated network solution with PHY (optional) Intel® C624 as 2x or 4x10GbE integrated network solution with PHY (optional) 																																		
Expansion slots	See <i>SKU information</i> on page 1-4 for more information.																																		
Storage	<p style="text-align: center;">2.5" SKU:</p> <ul style="list-style-type: none"> Tiered SKU: <table border="1" style="margin: 10px auto; width: 80%; border-collapse: collapse;"> <tr> <td style="background-color: #0070C0; color: white;">SAS/ SATA</td> <td style="background-color: #0070C0; color: white;">SAS/ SATA</td> <td style="background-color: #0070C0; color: white;">SAS/ SATA</td> <td style="background-color: #0070C0; color: white;">SAS/ SATA</td> <td style="background-color: #C00000; color: white;">U.2</td> <td style="background-color: #C00000; color: white;">U.2</td> </tr> <tr> <td style="background-color: #0070C0; color: white;">SAS/ SATA</td> <td style="background-color: #0070C0; color: white;">SAS/ SATA</td> <td style="background-color: #0070C0; color: white;">SAS/ SATA</td> <td style="background-color: #0070C0; color: white;">SAS/ SATA</td> <td style="background-color: #C00000; color: white;">U.2</td> <td style="background-color: #C00000; color: white;">U.2</td> </tr> </table> <ul style="list-style-type: none"> (8) SATA/SAS SSD/HDD (SFF-8680) (4) SATA/SAS SSD/HDD or NVMe SSD (SFF-8639) All Flash SKU: <div style="display: flex; justify-content: space-around; margin: 10px 0;"> 6x SSD from CPU0 6x SSD from CPU1 </div> <table border="1" style="margin: 10px auto; width: 80%; border-collapse: collapse;"> <tr> <td style="background-color: #C00000; color: white;">SATA/NVMe</td> <td style="background-color: #C00000; color: white;">SATA/NVMe</td> <td style="background-color: #C00000; color: white;">SATA/NVMe</td> <td style="background-color: #C00000; color: white;">SATA/NVMe</td> <td style="background-color: #C00000; color: white;">SATA/NVMe</td> <td style="background-color: #C00000; color: white;">SATA/NVMe</td> </tr> <tr> <td style="background-color: #C00000; color: white;">SATA/NVMe</td> <td style="background-color: #C00000; color: white;">SATA/NVMe</td> <td style="background-color: #C00000; color: white;">SATA/NVMe</td> <td style="background-color: #C00000; color: white;">SATA/NVMe</td> <td style="background-color: #C00000; color: white;">SATA/NVMe</td> <td style="background-color: #C00000; color: white;">SATA/NVMe</td> </tr> </table> <ul style="list-style-type: none"> (12) SATA SSD or (12) NVMe SSD <p style="text-align: center;">3.5" + 2.5" HYBRID SKU:</p> <table border="1" style="margin: 10px auto; width: 80%; border-collapse: collapse;"> <tr> <td style="background-color: #808080; color: white;">Front Panel</td> <td style="background-color: #C00000; color: white;">9mm U.2</td> <td style="background-color: #C00000; color: white;">9mm U.2</td> <td style="background-color: #C00000; color: white;">9mm U.2</td> <td style="background-color: #C00000; color: white;">9mm U.2</td> </tr> <tr> <td style="background-color: #0070C0; color: white;">3.5" SAS /SATA</td> <td style="background-color: #0070C0; color: white;">3.5" SAS /SATA</td> <td style="background-color: #0070C0; color: white;">3.5" SAS /SATA</td> <td style="background-color: #0070C0; color: white;">3.5" SAS /SATA</td> <td style="background-color: #0070C0; color: white;">3.5" SAS /SATA</td> </tr> </table> <ul style="list-style-type: none"> (4) 3.5" SATA/SAS SSD/HDD (SFF-8680) + (4) 2.5" SATA/NVMe 9mm SSD (SFF-8639) (optional) (4) 3.5" SATA/SAS SSD/HDD (SFF-8680) + (4) 2.5" SATA/SAS 9mm SSD (SFF-8639) (optional) 	SAS/ SATA	SAS/ SATA	SAS/ SATA	SAS/ SATA	U.2	U.2	SAS/ SATA	SAS/ SATA	SAS/ SATA	SAS/ SATA	U.2	U.2	SATA/NVMe	SATA/NVMe	SATA/NVMe	SATA/NVMe	SATA/NVMe	SATA/NVMe	SATA/NVMe	SATA/NVMe	SATA/NVMe	SATA/NVMe	SATA/NVMe	SATA/NVMe	Front Panel	9mm U.2	9mm U.2	9mm U.2	9mm U.2	3.5" SAS /SATA	3.5" SAS /SATA	3.5" SAS /SATA	3.5" SAS /SATA	3.5" SAS /SATA
SAS/ SATA	SAS/ SATA	SAS/ SATA	SAS/ SATA	U.2	U.2																														
SAS/ SATA	SAS/ SATA	SAS/ SATA	SAS/ SATA	U.2	U.2																														
SATA/NVMe	SATA/NVMe	SATA/NVMe	SATA/NVMe	SATA/NVMe	SATA/NVMe																														
SATA/NVMe	SATA/NVMe	SATA/NVMe	SATA/NVMe	SATA/NVMe	SATA/NVMe																														
Front Panel	9mm U.2	9mm U.2	9mm U.2	9mm U.2																															
3.5" SAS /SATA	3.5" SAS /SATA	3.5" SAS /SATA	3.5" SAS /SATA	3.5" SAS /SATA																															
Onboard storage	(2) SATADOM (optional)																																		
Video	Integrated Aspeed AST2500 with 8MB video memory																																		
Network options	<ul style="list-style-type: none"> (1) GbE dual or quad port OCP mezzanine PHY card (Optional)* (1) 10GbE dual or quad port OCP mezzanine PHY card (Optional)* More options refer to the CCL at www.qct.io <p>*The dual or quad port PHY card is installed to OCP mezzanine slot</p>																																		
Front I/O	<ul style="list-style-type: none"> Power/ID/Reset Buttons Power/ID/Status LEDs (2) USB ports 																																		

Table 1.1: System Specifications (Continued)

SPECIFICATIONS	DESCRIPTION
Rear I/O	<ul style="list-style-type: none"> ● (2) USB 3.0 ports ● (1) VGA port ● (1) RS232 serial port ● (1) GbE RJ45 management port ● (1) ID LED ● (1) MicroSD slot
TPM	Yes (optional, SPI mode)
ACPI	ACPI compliance, S0, S5 support
Power supply	<ul style="list-style-type: none"> ● 500W and 800W Titanium/Platinum redundant PSU, 100-240VAC 50/60Hz, AC/HVDC support ● 1100W redundant DC PSU: Acbel I/P: DC -39 - -72V, 37A max.
System rating	<ul style="list-style-type: none"> ● 100-120/200-240Vac, 50/60Hz, 6.5/3.3A or 240Vdc, 3A (Per PSU inlet) for PSU:500W and 800W ● 100-120/200-240Vac, 50/60Hz, 7.4/4A or 240Vdc, 3.7A (Per PSU inlet) for PSU:800W ● -39V- -72Vdc, 28A max. (Per PSU inet)
Fan	(8) dual rotor fans (15+1 redundant)
System management	IPMI v2.0 Compliant, on board "KVM over IP" support
Operating environment	<ul style="list-style-type: none"> ● Operating temperature: 5°C to 40°C (41°F to 104°F) ● Non-operating temperature: -40°C to 70°C (-40°F to 158°F) ● Operating relative humidity: 20% to 85%RH ● Non-operating relative humidity: 10% to 95%RH

Note:

Internal USB port is reserved for UDK USB drive installation only. Feature hot plug is not available on this internal USB port.

SKU information

2.5" All Flash SKU

6x SSD from CPU0

6x SSD from CPU1

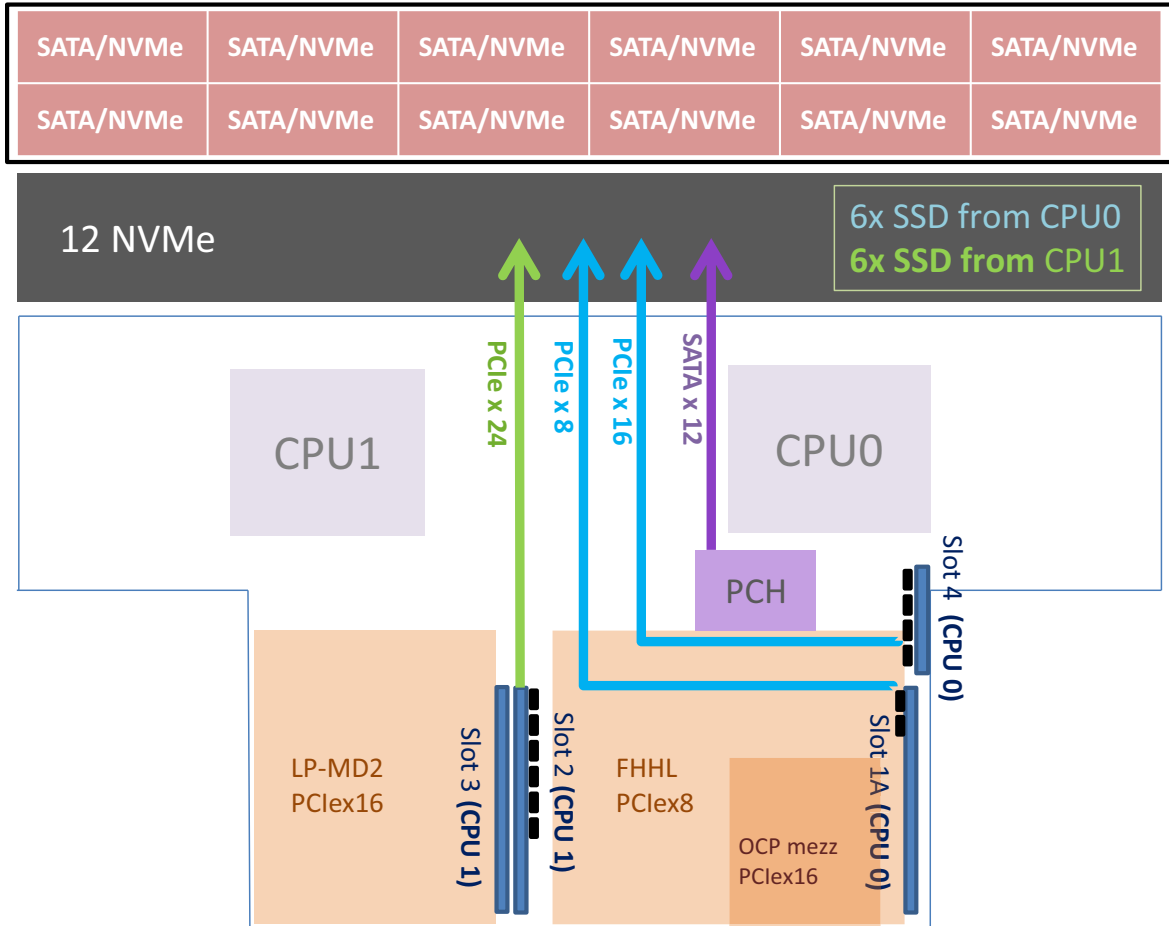

*Support SAS channel card on Slot 3.

2.5" Tiered SKU

SAS/ SATA	SAS/ SATA	SAS/ SATA	SAS/ SATA	U.2	U.2
SAS/ SATA	SAS/ SATA	SAS/ SATA	SAS/ SATA	U.2	U.2

Legend:
U.2 = SAS/SATA/NVMe

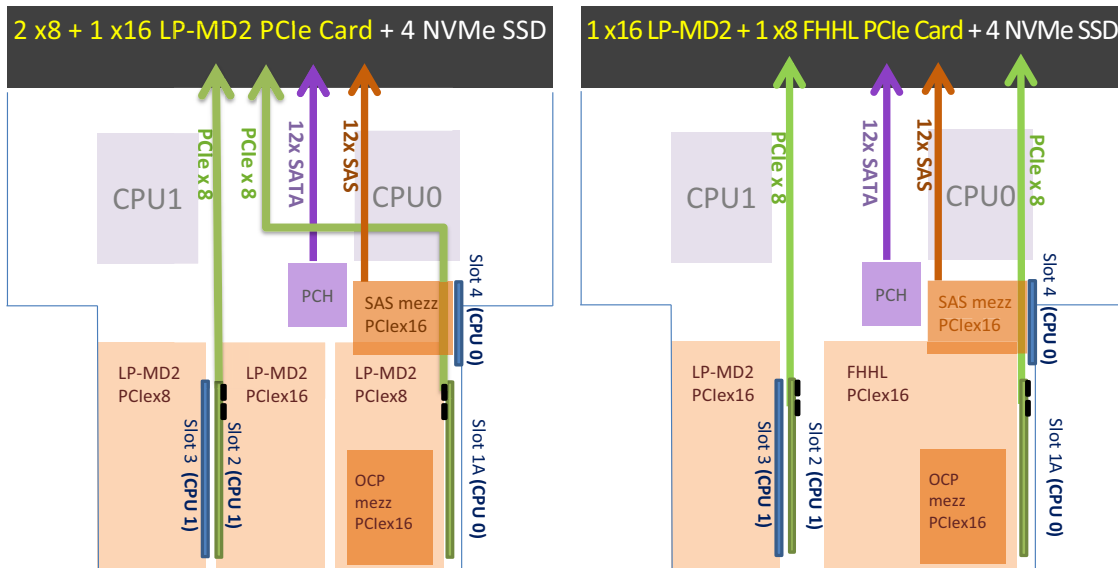

3.5"+2.5" Hybrid SKU

Front Panel	9mm U.2	9mm U.2	9mm U.2	9mm U.2
3.5" SAS /SATA	3.5" SAS /SATA	3.5" SAS /SATA	3.5" SAS /SATA	

Legend:
U.2 = SAS/SATA/NVMe

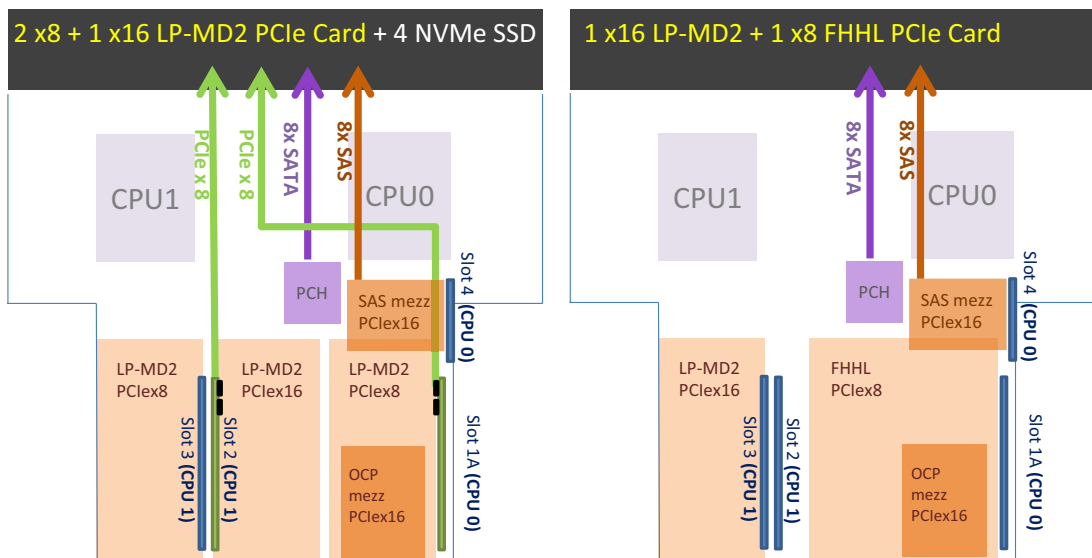

LAN On Motherboard (LOM) firmware information

Table 2: Intel C621 EEPROM default values*:

ITEMS	DESCRIPTION
Firmware version	00.01

Table 2: Intel C621 EEPROM default values* :

ITEMS	DESCRIPTION
SSID	89EF
VID/DID	152D (SubVendor) 8086 (Vendor)/1528
SR-IOV	Yes
LED	Yes
Management Support for BMC (NCSI/SMBUS/MCTP)	NCSI
iSCSI boot	uEFI/Legacy
PXE	uEFI/Legacy
WOL support	Yes
ROL support	No
Speed	Auto
ASPM	L0S/L1

Table 3: Intel C624 EEPROM default values* :

ITEMS	DESCRIPTION
Firmware version	10.63
SSID	89E3
VID/DID	152D (SubVendor) 8086 (Vendor)/1521
SR-IOV	Yes
LED	Yes
Management Support for BMC (NCSI/SMBUS/MCTP)	NCSI
iSCSI boot	Legacy
PXE	Legacy
WOL support	Yes
ROL support	No
Speed	Auto
ASPM	L0S/L1

*Note: Please check the readme file first for the latest information from your LOM firmware package if the version number is older than your system.

1.2 Package Contents

- (1) D52B-1U system
- (2) processor heat sinks
- (1) power supply unit
- (1) power cord (optional)

Note:

Note: For exact shipping contents, contact your QCT sales representative.

1.3 A Tour of the System

System Overview

The server is available as a 2.5" and hybrid 3.5" + 2.5" storage drive configuration.

The 2.5" storage drive system overview is displayed in the following image:

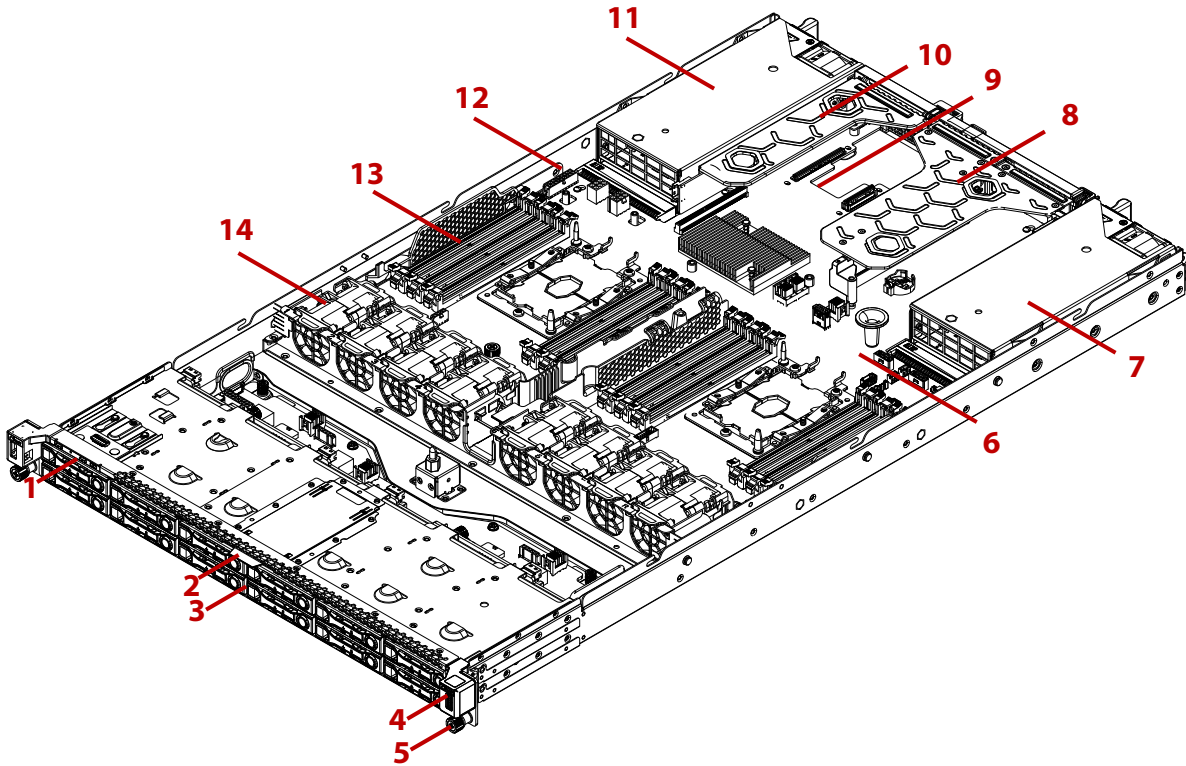

Figure 1-1. 2.5" Storage Drive System Component Overview

Table 4: Component Overview

No.	ITEM	DESCRIPTION
1	Front control panel	See <i>Enabling the Intel® VMD technology</i> on page 1-16
2	Asset tag	Record serial number or other important information
3	2.5" storage drive tray	Housing up to twelve 2.5" storage drive (15mm)
4	USB port	Connect to USB device
5	Thumb screw	Secure the system to rack frame
6	Mainboard	System mainboard
7	PSU assembly	Redundant power supply unit assembly
8	Riser assembly (CPU1)	Support PCIe add-on card installation with riser feature.
9	OCP slot (CPU0)	Support OCP 2.0 mezzanine card installation.

Table 4: Component Overview (Continued)

No.	ITEM	DESCRIPTION
10	Riser assembly (CPU0)	Support PCIe add-on card installation with riser feature.
11	PSU assembly	Redundant power supply unit assembly
12	SuperCAP carrier	Housing SuperCAP using in SAS mezzanine card or SAS add-on card
13	DIMM slots	(12) DDR4 DIMM slots per CPU
14	Fan module	(8) System fan modules

The hybrid 3.5" + 2.5" storage drive configuration system overview is displayed in the following image:

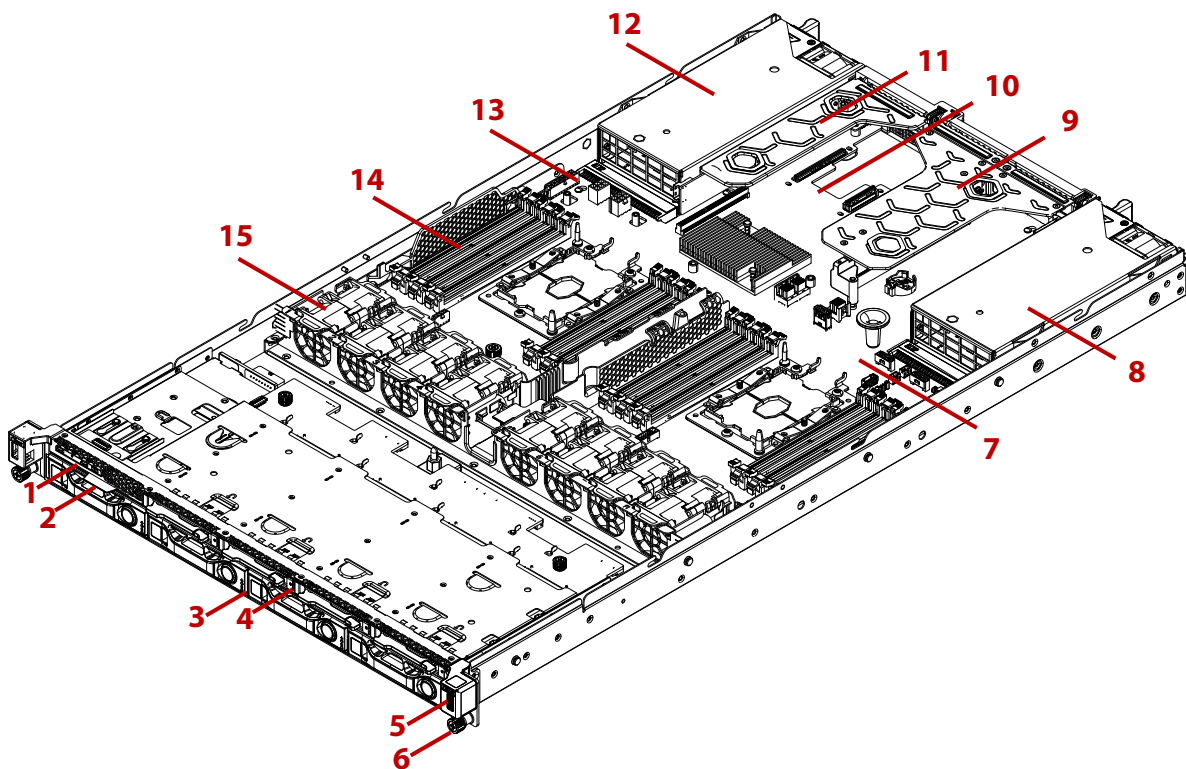

Figure 1-2. Hybrid 3.5" + 2.5" Storage Drive System Component Overview

Table 5: Component Overview

No.	ITEM	DESCRIPTION
1	Front control panel	See <i>Enabling the Intel® VMD technology</i> on page 1-16
2	Asset tag	Record serial number or other important information
3	3.5" HDD tray	Housing up to four 3.5" SATA/SAS drive
4	2.5" HDD tray	Housing up to four 2.5" SATA/NVMe drive (optional)
5	USB port	Connect to USB device
6	Thumb screw	Secure the system to rack frame

Table 5: Component Overview (Continued)

No.	ITEM	DESCRIPTION
7	Mainboard	System mainboard
8	PSU assembly	Redundant power supply unit assembly
9	Riser assembly (CPU1)	Support PCIe add-on card installation with riser feature.
10	OCP slot (CPU0)	Support OCP 2.0 mezzanine card installation.
11	Riser assembly (CPU0)	Support PCIe add-on card installation with riser feature.
12	PSU assembly	Redundant power supply unit assembly
13	SuperCAP carrier	Housing SuperCAP using in SAS mezzanine card or SAS add-on card
14	DIMM slots	(12) DDR4 DIMM slots per CPU
15	Fan module	(8) System fan modules

System Front View

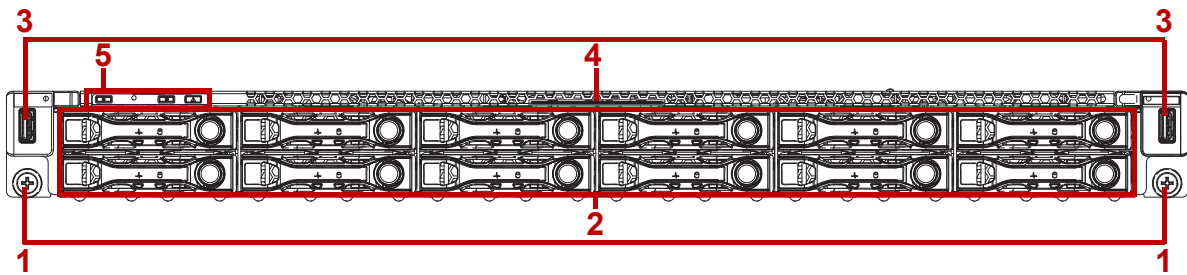

Figure 1-3. 2.5" Storage Drive System Front View

Table 6: Front View

No.	NAME	DESCRIPTION
1	Thumb screw	Secure the system to rack frame
2	2.5" storage drive tray	Housing up to twelve 2.5" storage drive (15mm):
3	USB port	Connect to USB device
4	Asset tag	Record serial number or other important information
5	Front control panel	See <i>Front Control Panel LEDs</i> on page 1-21 for further information.

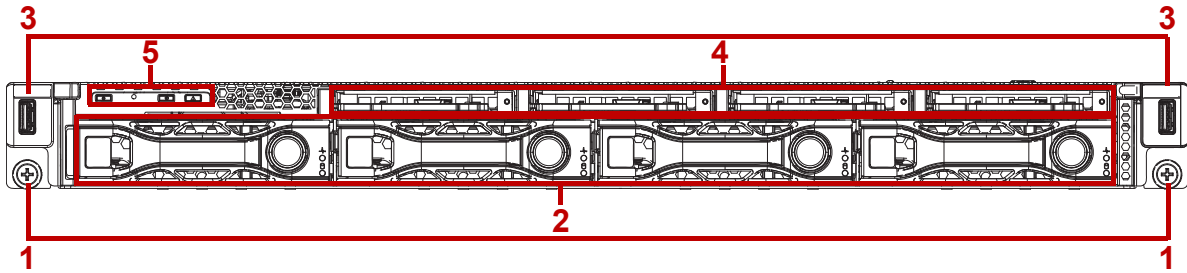

Figure 1-4. Hybrid 3.5" + 2.5" Storage Drive System Front View

Table 7: Front Panel View

No.	NAME	DESCRIPTION
1	Thumb screw	Secure the system to rack frame
2	3.5" HDD tray	4 x 3.5" SATA/SAS drive
3	USB port	Connect to USB device
4	2.5" HDD tray (9mm)	<ul style="list-style-type: none"> 4x 2.5" SATA/SAS/NVMe drive (optional) 4x 2.5" SATA/SAS drive (optional)
5	Front control panel	See <i>Front Control Panel LEDs</i> on page 1-21 for further information.

Front Control Panel (FCP)

For purposes of this procedure, the FCP is used for the numbering indicators.



Figure 1-5. Front Control Panel

Table 8: Front Control Panel Definition

No.	ICON	NAME	DESCRIPTION
1		Power button with LED	Power on / off Blue on - S0 system power on; Off - S5 system power off
2		Reset button	Soft reset system function
3		Identification button with LED	Toggles ID LED, activate ID LED to identify system Blue blinking - Identifier on front and rear chassis; Off - Normal.
4		System Status LED	Provides critical and non-critical failure notification Amber blinking - failed; Off - SEL cleared / good

System Rear View

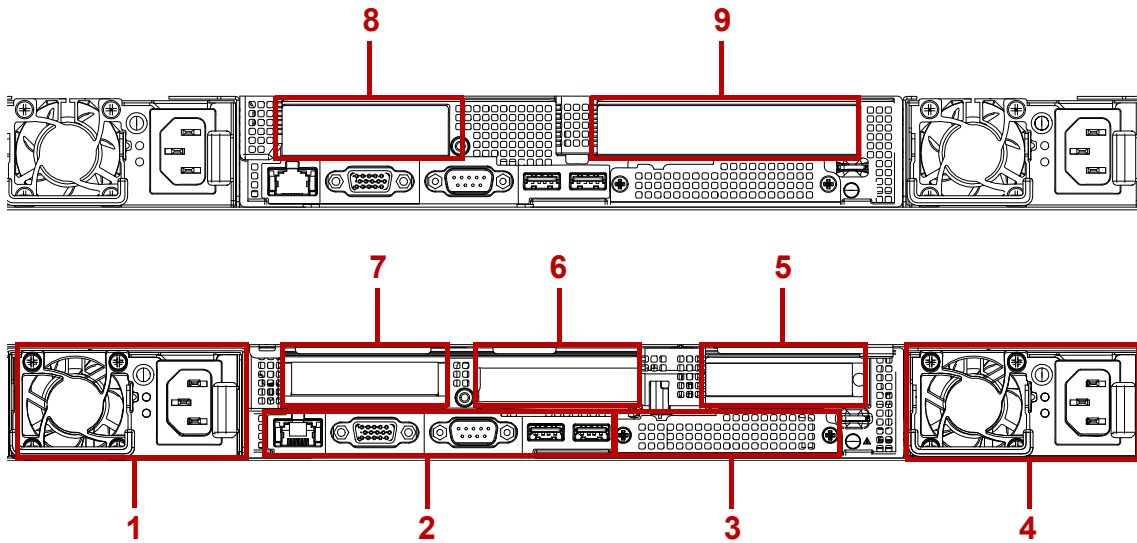

Figure 1-6. System Rear View

Table 9: System Rear View

No.	FEATURE	DESCRIPTION
1	Power sub-system	Main power supply unit (PSU0). See <i>Power Sub-System</i> on page 1-13.
2	System I/O ports	See <i>System Rear I/O</i> on page 1-12
3	Expansion slot	Support OCP 2.0 mezzanine card installation (CPU0)
4	Power sub-system	Main power supply unit (PSU1). See <i>Power Sub-System</i> on page 1-13.
5	Expansion slot	PCIe expansion slot with LP MD-2 (CPU0)
6	Expansion slot	PCIe expansion slot with LP MD-2 (CPU1)
7	Expansion slot	PCIe expansion slot with LP MD-2 (CPU1)
8	Expansion slot	PCIe expansion slot with LP MD-2 (CPU1)
9	Expansion slot	PCIe expansion slot with FHHL (CPU0)

System Rear I/O

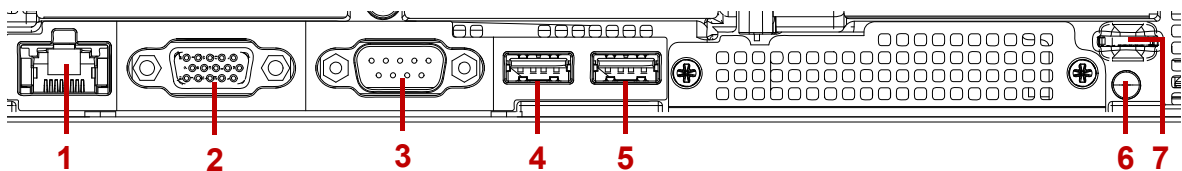







Figure 1-7. System Rear I/O

Table 10: System Rear I/O Definition

No.	ICON	NAME	DESCRIPTION
1		Dedicated NIC	Dedicated RJ45 connector
2		VGA connector	Maximum display resolution: 1920x1200 32bpp@60Hz (reduced blanking)
3		COM A port	DB9 port (Serial_A) for debug or terminal concentrator
4		USB 3.0 port	USB 1 port; connect to USB device
5			USB 0 port; connect to USB device
6		Identification LED	Blue blinking - Identifier; Off - Normal.
7		MicroSD slot	Backup BMC SEL.

Power Sub-System

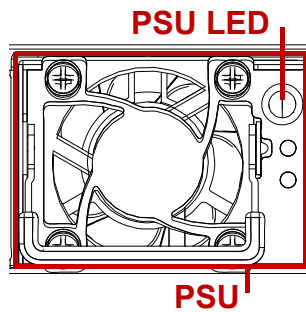

Figure 1-8. PSU to Mainboard Module Description

A single power supply unit (default) is supplied in the system. A secondary PSU is available for redundancy functionality.

Table 11: AC Power Supply Units by Model

PSU	AC INPUT
2 x 500W and 800W Titanium/Platinum high efficiency redundant PSU	100-240VAC 50/60Hz, AC/HVDC support

Table 12: DC Power Supply Units by Model

PSU	DC INPUT
2 x 1100W high efficiency redundant DC PSU	DC -39 - -72V, 37A max.

Table 13: Power Supply Unit LED

PSU LED COLOR	DESCRIPTION
Amber On	PSU failure
Green On	PSU good
Green Blinking at 0.5Hz	PSU standby
Green Blinking at 2Hz	PSU cold redundancy standby

HDD / M.2 Adapter Configuration

The systems are available as a full 2.5" or hybrid 3.5"+2.5" SKU. Within the HDD array, the HDD enumeration is as follows:

Full 2.5" HDD Configuration



ALL FLASH SKU

HDD0~HDD11 support SATA or NVMe SSD*

TIERED SKU

HDD0~HDD7 support SATA/SAS HDD/SSD;
HDD8~HDD11 support SATA/SAS HDD/SSD or NVMe SSD*

Figure 1-9. Full 2.5" HDD Configuration

Table 14: Intel® VMD PCIe Root Port BIOS Setup Option Table (only for NVMe SSD)

HDD SLOT#	ALL FLASH SKU			TIERED SKU					
	CPU SOCKET	PSTACK	VMD PORT	CPU SOCKET	PSTACK	VMD PORT			
0	0	0	1A	N/A					
1			1B						
2		2	3A						
3			3B						
4			3C						
5	3D								
6	1	0	1A				0	0	1A
7			1B						
8			1C						1B
9			1D						
10		2	1				3A	2	3A
11				3B	3B				

Hybrid 3.5"+2.5" HDD Configuration

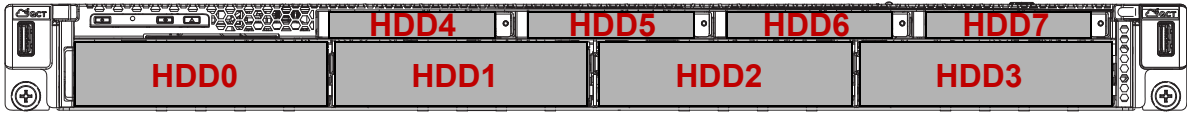

ALL SATA/SAS SKU	3.5" SATA/SAS + 2.5" SATA/SAS/NVMe SKU
HDD0~HDD7 support SATA/SAS HDD/SSD	HDD0~HDD3 support SATA/SAS HDD/SSD
	HDD4~HDD7 support SATA/SAS HDD/SSD or NVMe SSD

Figure 1-10. Hybrid 3.5" + 2.5" HDD Configuration

Table 15: Intel® VMD PCIe Root Port BIOS Setup Option Table (only for NVMe SSD)

HDD SLOT#	CPU SOCKET	PSTACK	VMD PORT
4	0	0	1A
5			1B
6	1	2	3A
7			3B

NVMe SSD M.2 Adapter Add-On Card (Optional)

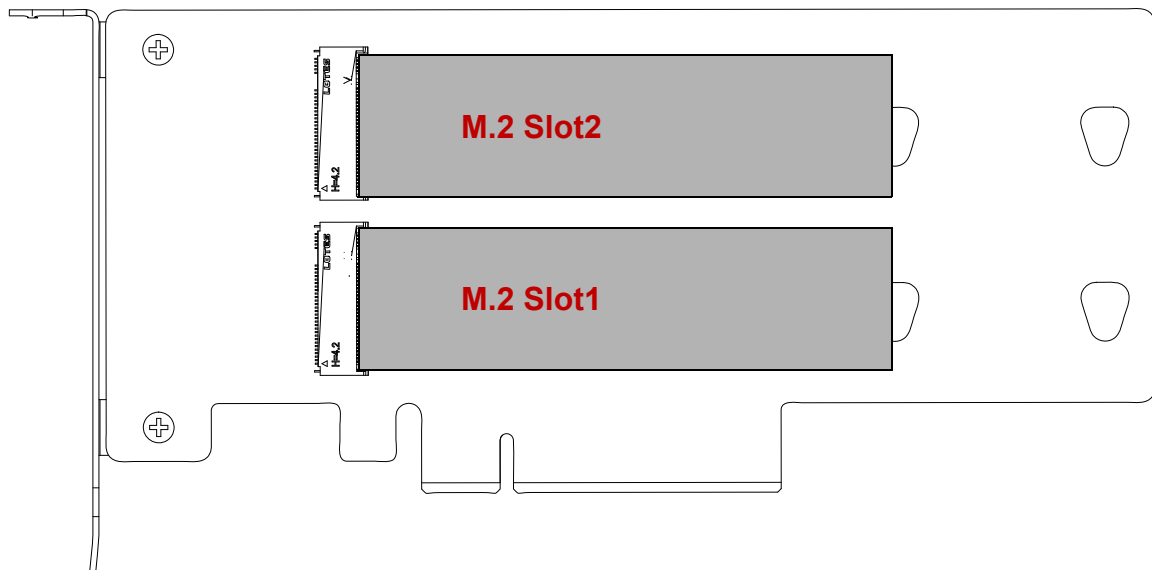

Figure 1-11. M.2 Slot Number

Table 16: Intel® VMD PCIe Root Port BIOS Setup Option Table

M.2 SLOT#	CPU SOCKET	PSTACK	VMD PORT
1	0	0	1C
2			1D

Note: The M.2 SSD is installed for OS installation only.

Enabling the Intel® VMD technology

Note:

You can use Intel® VROC HII to create the RAID volume. These volume can be created at any point before or after your system is successfully running your Windows installation, but may not be used as the boot volume.

To enable the Intel VMD technology feature, you might need to select “Intel® VMD technology” in “IIO configuration” under the “Socket Configuration” screen from BIOS Main screen by pressing the right arrow until the Socket Configuration screen is chosen.

Press the right arrow key until “Socket Configuration” is selected and press the down arrow key until “IIO Configuration” is selected.

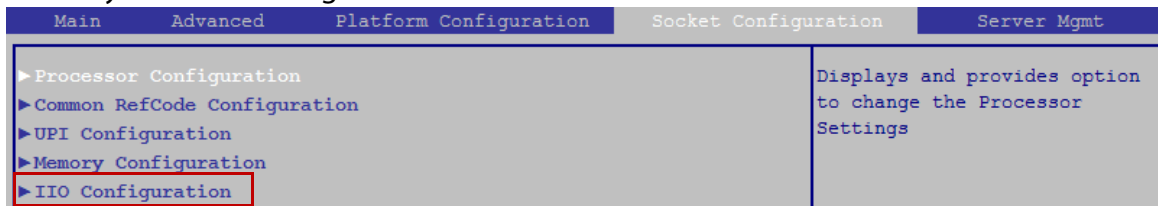

Press the down arrow key until “Intel® VMD technology” is selected.

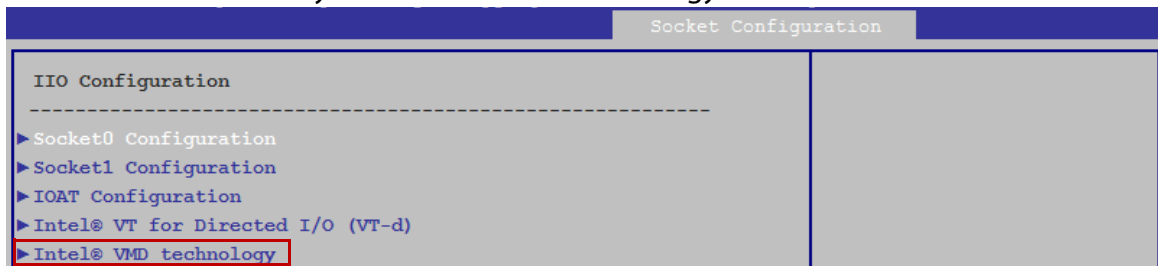

Enable your VMD PCIe Root Port based on the following configuration table:

ALL FLASH SKU

0-0-0-1A	2-0-2-3A	4-0-2-3C	6-1-0-1A	8-1-0-1C	10-1-2-3A
1-0-0-1B	3-0-2-3B	5-0-2-3D	7-1-0-1B	9-1-0-1D	11-1-2-3B

TIERED SKU

N/A	N/A	N/A	N/A	8-0-0-1A	10-1-2-3A
N/A	N/A	N/A	N/A	9-0-0-1B	11-1-2-3B

	4-0-0-1A	5-0-0-1B	6-1-2-3A	7-1-2-3B
N/A	N/A	N/A	N/A	N/A

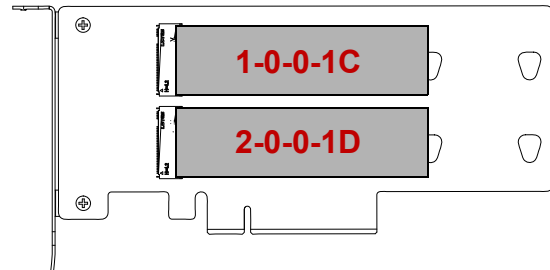

NVME M.2 ADAPTER

Press up or down arrow key to select CPU socket0 or CPU socket1.

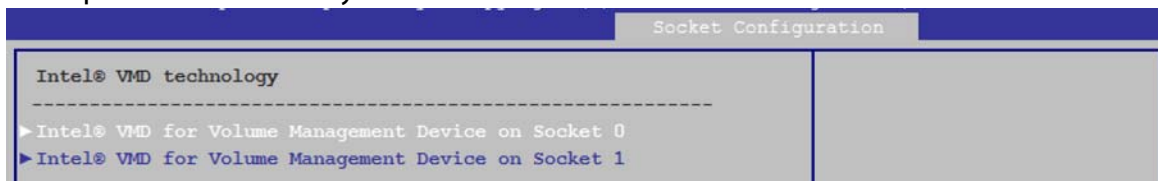

Then you can enable/disable the Intel® VMD feature for your system.

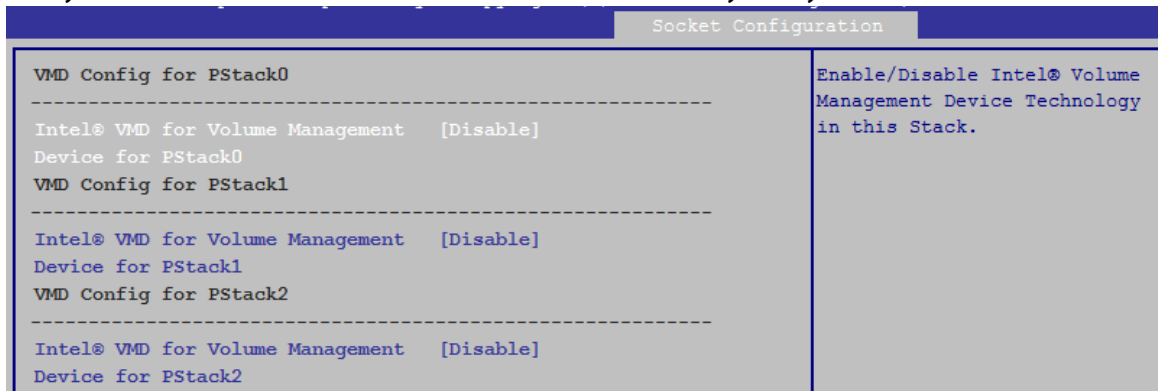

Table 17: Intel® VMD on Socket X Screen Description

SETUP ITEM	OPTIONS	HELP TEXT	COMMENTS
VMD Config for PStack0			Information only.
Intel® VMD for Volume Management Device for PStack0	[Disable] [Enable]	Enable/Disable Intel® Volume Management Device Technology in this Stack.	
VMD Config for PStack1			
Intel® VMD for Volume Management Device for PStack1	[Disable] [Enable]	Enable/Disable Intel® Volume Management Device Technology in this Stack.	
VMD Config for PStack2			
Intel® VMD for Volume Management Device for PStack2	[Disable] [Enable]	Enable/Disable Intel® Volume Management Device Technology in this Stack.	

Spanning RAID data volumes across VMD domains

To enable the spanning RAID data volumes across VMD domains feature, you might need to select “Enable RAID spanned over VMD Controllers ” in “Intel(R) Virtual RAID on CPU” (VROC) under the “Advanced” screen from BIOS Main screen by pressing the right arrow until the Advanced screen is chosen.

Press the right arrow key until “Advanced” is selected and press the down arrow key until “Intel(R) Virtual RAID on CPU” is selected.

1. Press F2 or Del to enter into the BIOS configuration the setup menu and press right arrow key to access the “Advanced” page.
2. Navigate to and select “Intel(R) Virtual RAID on CPU”.

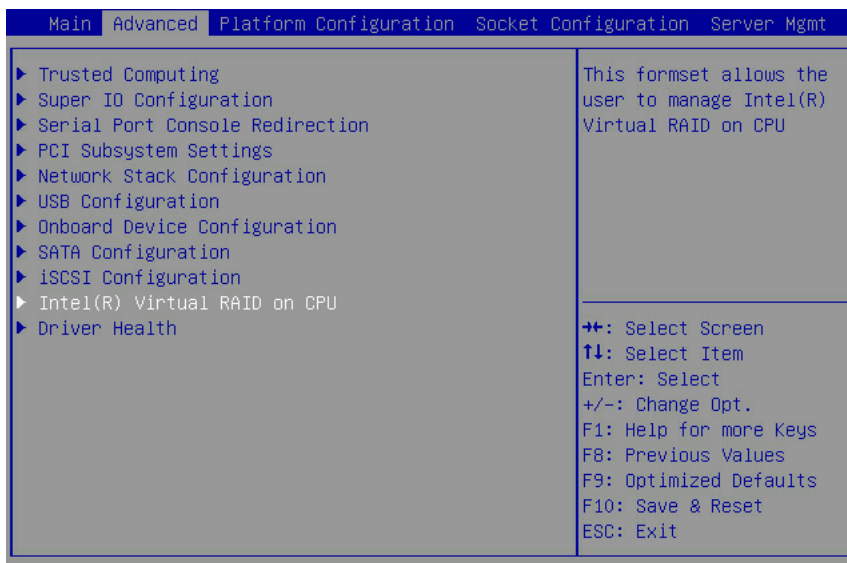

3. Navigate to and select "All Intel VMD Controllers"

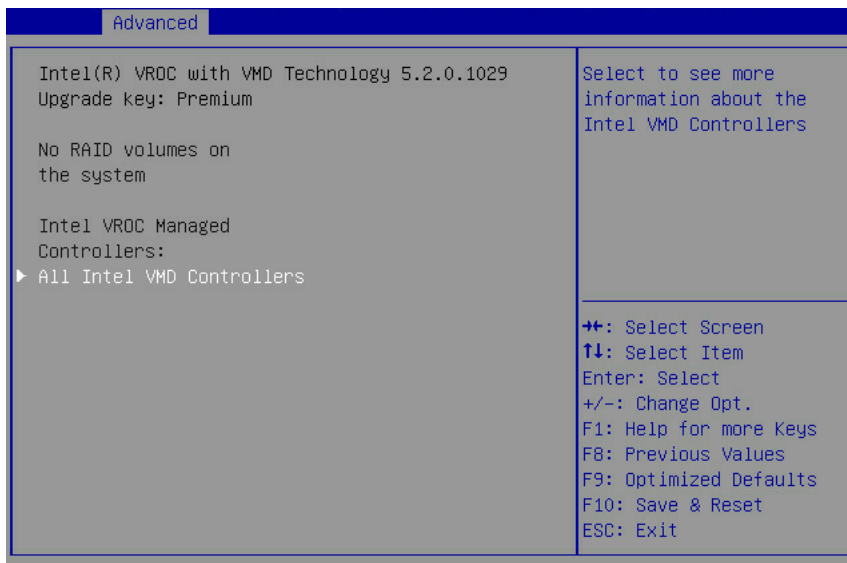

4. Navigate to and select "Create RAID Volume"

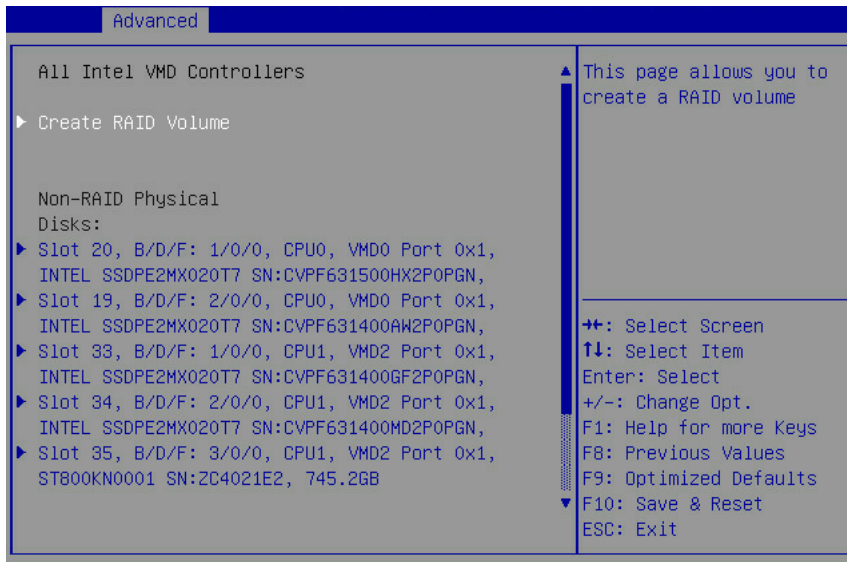

5. To enable the RAID to be spanned over multiple controllers, highlight the [], and press <Enter>. This will open a small menu box with two values, blank and X. Blank

indicates a setting that is disabled. To enable RAID spanned over VMD Controllers, highlight X and press the <Enter> key.

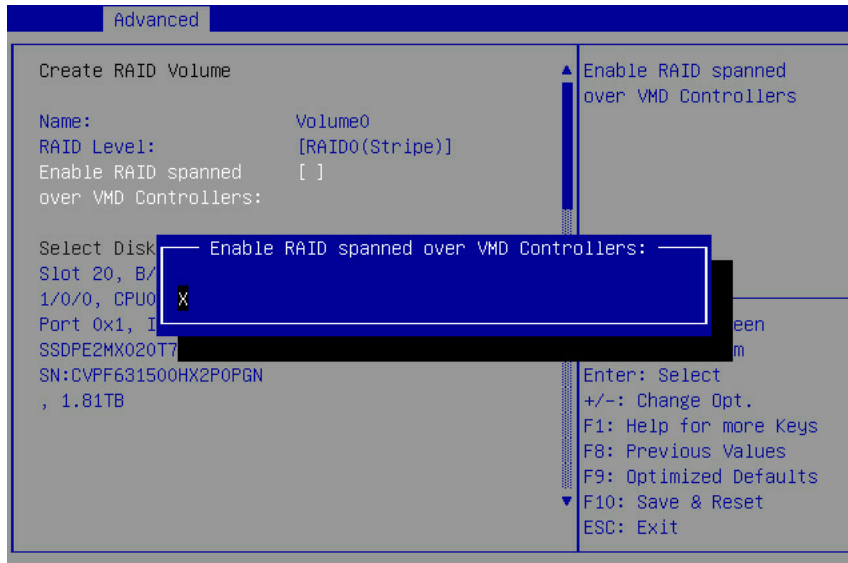

6. Navigate to and select Create Volume, then press <Enter>.

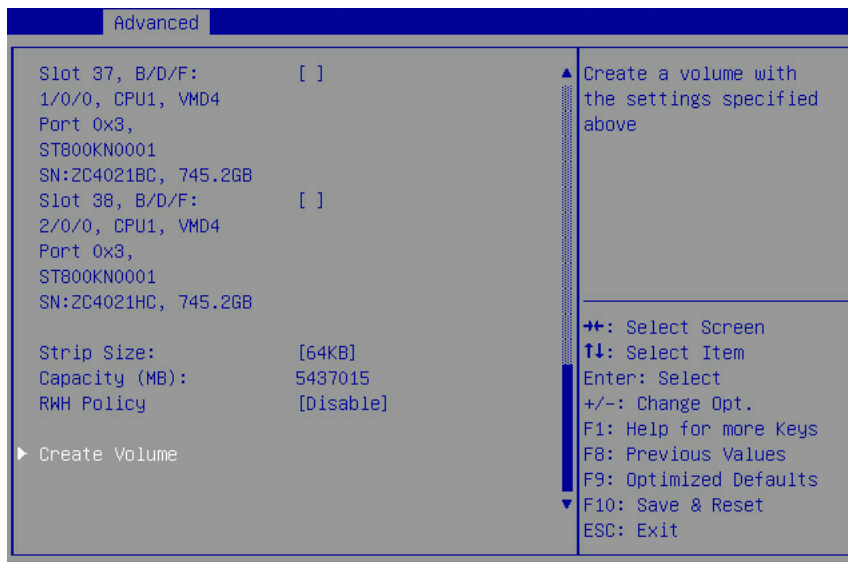

7. The following message will be displayed: "You have selected NVMe drives that are connected to multiple VMD controllers. Please note that if you continue and create

a RAID volume with drives from multiple VMD controllers that RAID volume will not be bootable in a Windows* OS environment. Press 'y' to create, 'n' to discard".

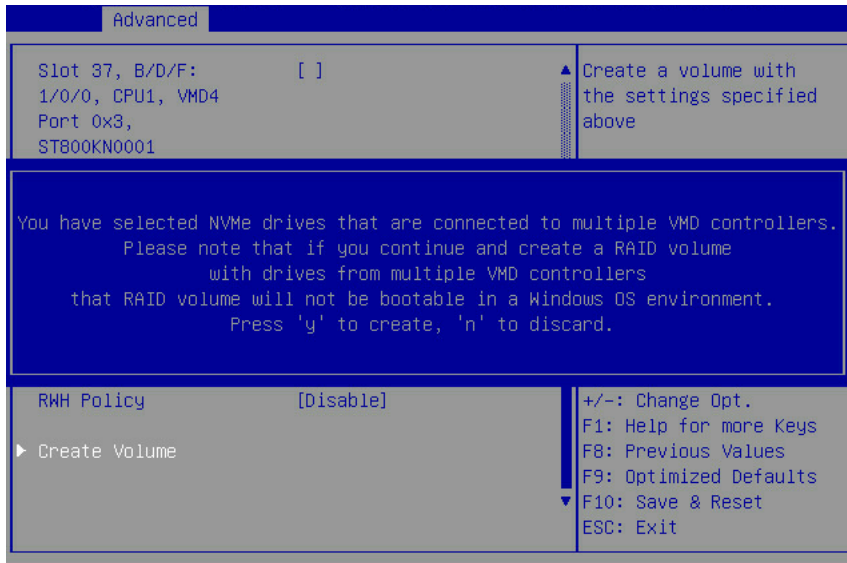

Note:

The message is a warning regarding Windows. This is a BIOS configuration platform and can be compatible with either Windows* Server or Linux distributions. However spanned boot volumes in Windows* are not supported.

LED Status Definitions

Front Control Panel LEDs

For location of the FCP, see *System Front View* on page 1-10.



Figure 1-12. Front Control Panel LEDs

Table 18: Front Control Panel LEDs Behavior

NAME	COLOR	CONDITION	DESCRIPTION
Power LED	Blue	On	System S0 power on
		Off	System S5 power off
Identification	Blue	Blinking	Unit selected for identification
		Off	No identification request

Table 18: Front Control Panel LEDs Behavior (Continued)

NAME	COLOR	CONDITION	DESCRIPTION
Status LED	Amber	Blinking	Critical Failure: critical fan, voltage, temperature state.
			Non-Critical Failure: non-critical fan, voltage, temperature state, CPU thermal trip, DC off.
		Off	SEL cleared
			Last pending warning or error has been de-asserted.

BMC Management Port LEDs

The system mainboard includes one dedicated RJ45 GbE management port. The RJ45 connector has two built-in LEDs. See the following illustration and table for details.

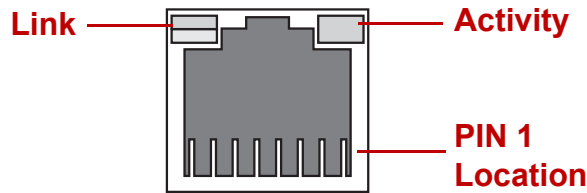

Figure 1-13. GbE RJ45 Management Port

Table 19: RJ45 LED Description

CONDITION	LINK	ACTIVITY
Unplugged	Off	Off
1G active link	On amber	Blinking green
100M active link	On green	Blinking green
10M active link	Off	Blinking green

Storage Drive LED

Front 2.5" Storage Drive LED Status Behavior

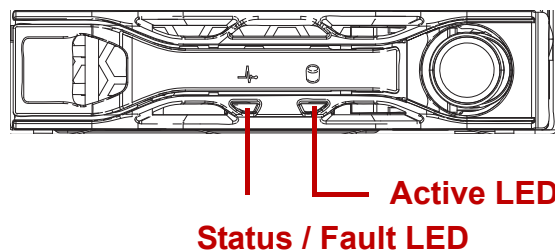

Figure 1-14. 2.5" Storage Drive LED Identification

The following LED behavior table represents LED conditions.

Table 20: 2.5" Storage Drive LED Status Behavior

NAME	COLOR	CONDITION	DESCRIPTION
Drive Status / Fault	Blue	On	Drive is online
		Blinking	Twice per second: Identification Once per second: Rebuilding
	Amber	On	HDD failure
	Off		Slot is empty
Drive Active	Blue	Blinking	HDD access is active

Front 3.5" Storage Drive LED Status Behavior

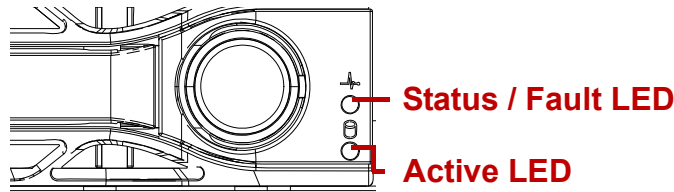

Figure 1-15. 3.5" Storage Drive LED Identification

The following LED behavior table represents LED conditions.

Table 21: 3.5" Storage Drive LED Status Behavior

NAME	COLOR	CONDITION	DESCRIPTION
Drive Status / Fault	Blue	On	Drive is online
		Blinking	Twice per second: Identification Once per second: Rebuilding
	Amber	On	HDD failure
	Off		Slot is empty
Drive Active	Blue	Blinking	HDD access is active

Front 2.5" Storage Drive LED Status Behavior

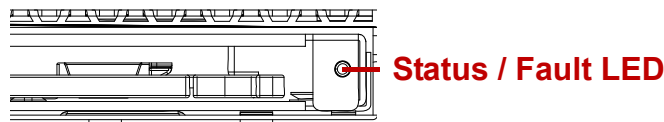

Figure 1-16. 2.5" Storage Drive LED Identification

The following LED behavior table represents LED conditions.

Table 22: Storage Drive LED Status Behavior

NAME	COLOR	CONDITION	DESCRIPTION
Drive Status / Fault	Blue	Blinking	Twice per second: Identification Once per second: Rebuilding
		On	Drive is online
	Amber		HDD failure
	Off		Slot is empty

Enabling Platform Trusted Technology (PTT)

To enable platform trusted technology feature, you might need to select “Server ME Configuration” in “Platform Configuration” screen from BIOS Main screen by pressing the right arrow until the Platform Configuration screen is chosen. Press the down arrow key until “Server ME Configuration” is selected.

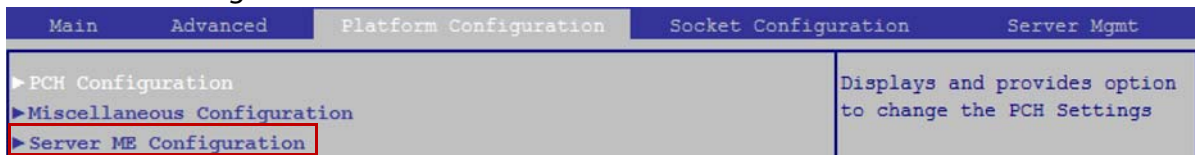

Press down arrow key to select PTT Support. Then you can enable/disable the PTT feature for your system

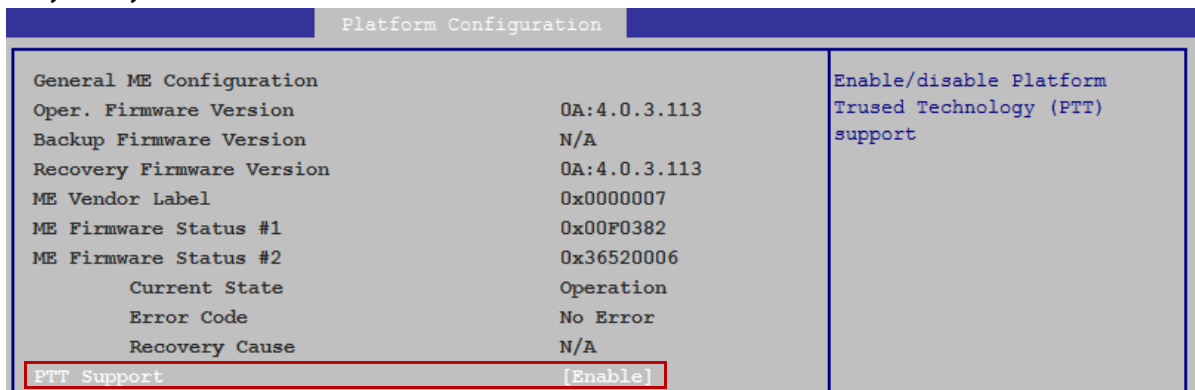

TPM configuration settings

To setup the TPM configuration, you might need to select “Trusted Computing” in “Advanced” screen from BIOS Main screen by pressing the right arrow until the Advanced screen is chosen. Press the down arrow key until “Trusted Computing” is selected.

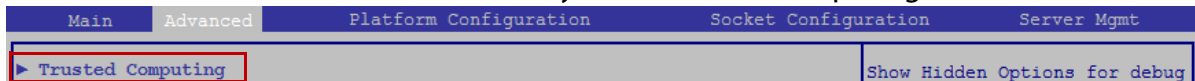

Now you can setup the TPM configuration.

Main	Advanced	Platform Configuration	Socket Configuration	Server Mgmt
Configuration TPM2.0 Device Found Active PCR banks SHA-1, SHA256 Availible PCR banks SHA-1, SHA256 SHA-1 PCR bank [Enabled] SHA256 PCR banks [Enabled] Pending operation [None] PH Randmization [Enabled]				Enable or Disable SHA-1 PCR banks

Table 23: Configuration on Trusted Computing Screen Description

SETUP ITEM	OPTIONS	HELP TEXT	COMMENTS
TPM 2.0 Device Found			Information only. Displays current TPM Status.
Active PCR banks			Information only. Displays current active PCR banks.
Available PCR banks			Information only. Displays current available PCR banks.
SHA-1 PCR Bank	[Disabled] [Enabled]	Enable or Disable SHA-1 PCR Bank	Only appears when "Available PCR banks" includes this type.
SHA256 PCR Bank	[Disabled] [Enabled]	Enable or Disable SHA256 PCR Bank	Only appears when "Available PCR banks" includes this type.
Pending operation	[None] [TPM Clear]	Enable/Disable Security Device. NOTE: Your computer will reboot during restart in order to change state of the device.	Only appears when TPM device exist
PH Randomization	[Disabled] [Enabled]	Enables or Disables Platform Hierachy randomization.	Only appears when TPM device exist

Regulatory and Compliance Information

Chapter 2

This section provides regulatory and compliance information applicable to this system.

Server Safety Information

To reduce the risk of bodily injury, electrical shock, fire, and equipment damage, read this document and observe all warnings and precautions in this guide before installing or maintaining your server product.

In the event of a conflict between the information in this document and information provided with the product or on the website for a particular product, the product documentation takes precedence.

Your server should be integrated and serviced only by technically qualified persons.

You must adhere to the guidelines in this guide and the assembly instructions in your server manuals to ensure and maintain compliance with existing product certifications and approvals. Use only the described, regulated components specified in this guide. Use of other products / components will void the UL Listing and other regulatory approvals of the product, and may result in noncompliance with product regulations in the region(s) in which the product is sold.

Safety Warnings and Cautions

To avoid personal injury or property damage, before you begin installing the product, read, observe, and adhere to all of the following safety instructions and information. The following safety symbols may be used throughout the documentation and may be marked on the product and / or the product packaging.

CAUTION	Indicates the presence of a hazard that may cause minor personal injury or property damage if the CAUTION is ignored.
WARNING	Indicates the presence of a hazard that may result in serious personal injury if the WARNING is ignored.
	Indicates potential hazard if indicated information is ignored.
	Indicates shock hazards that result in serious injury or death if safety instructions are not followed.
	Indicates hot components or surfaces.
	Indicates do not touch fan blades, may result in injury.
	Indicates to unplug all AC power cord(s) to disconnect AC power.
	Please recycle battery.
	The rail racks are designed to carry only the weight of the server system. Do not use rail-mounted equipment as a workspace. Do not place additional load onto any rail-mounted equipment.
	Indicates four or more people are required to safely handle the system.

Intended Application Uses

This product was evaluated as Information Technology Equipment (ITE), which may be installed in offices, schools, computer rooms, and similar commercial type locations. The suitability of this product for other product categories and environments (such as medical, industrial, residential, alarm systems, and test equipment), other than an ITE application, may require further evaluation.

Site Selection

The system is designed to operate in a typical office environment. Choose a site that is:

- Clean, dry, and free of airborne particles (other than normal room dust).
- Well-ventilated and away from sources of heat including direct sunlight and radiators.
- Away from sources of vibration or physical shock.
- Isolated from strong electromagnetic fields produced by electrical devices.
- In regions that are susceptible to electrical storms, we recommend you plug your system into a surge suppressor and disconnect telecommunication lines to your modem during an electrical storm.
- Provided with a properly grounded wall outlet.
- Provided with sufficient space to access the power supply cord(s), because they serve as the product's main power disconnect.
- Provided with either two independent AC power sources or two independent phases from a single source.

Equipment Handling Practices

Reduce the risk of personal injury or equipment damage:

- Conform to local occupational health and safety requirements when moving and lifting equipment.
- Use mechanical assistance or other suitable assistance when moving and lifting equipment.
- To reduce the weight for easier handling, remove any easily detachable components.

Power and Electrical Warnings

Caution: The power button, indicated by the stand-by power marking, DOES NOT completely turn off the system AC power, 5V standby power is active whenever the system is plugged in. To remove power from system, you must unplug the AC power cord from the wall outlet. Your system may use more than one AC power cord. Make sure all AC power cords are unplugged. Make sure the AC power cord(s) is / are unplugged before you open the chassis, or add or remove any non hot-plug components.

Do not attempt to modify or use an AC power cord if it is not the exact type required. A separate AC cord is required for each system power supply.

Some power supplies in servers use Neutral Pole Fusing. To avoid risk of shock use caution when working with power supplies that use Neutral Pole Fusing.

The power supply in this product contains no user-serviceable parts. Do not open the power supply. Hazardous voltage, current and energy levels are present inside the power supply. Return to manufacturer for servicing.

When replacing a hot-plug power supply, unplug the power cord to the power supply being replaced before removing it from the server.

To avoid risk of electric shock, turn off the server and disconnect the power cord, telecommunications systems, networks, and modems attached to the server before opening it.

Power Cord Warnings

If an AC power cord was not provided with your product, purchase one that is approved for use in your country.

Only use certified AC power cord to connect to both the power distribution unit (PDU) and server system installed in your rack.

Caution: *To avoid electrical shock or fire, check the power cord(s) that will be used with the product as follows:*

- *Do not attempt to modify or use the AC power cord(s) if they are not the exact type required to fit into the grounded electrical outlets.*
- *The power cord(s) must meet the following criteria:*
 - *The power cord must have an electrical rating that is greater than that of the electrical current rating marked on the product.*
 - *The power cord must have safety ground pin or contact that is suitable for the electrical outlet.*
 - *The power supply cord(s) is / are the main disconnect device to AC power. The socket outlet(s) must be near the equipment and readily accessible for disconnection.*
 - *The power supply cord(s) must be plugged into socket-outlet(s) that is /are provided with a suitable earth ground.*

System Access Warnings

Caution: *To avoid personal injury or property damage, the following safety instructions apply whenever accessing the inside of the product:*

- *Turn off all peripheral devices connected to this product.*
- *Turn off the system by pressing the power button to off.*
- *Disconnect the AC power by unplugging all AC power cords from the system or wall outlet.*
- *Disconnect all cables and telecommunication lines that are connected to the system.*
- *Retain all screws or other fasteners when removing access cover(s). Upon completion of accessing inside the product, refasten access cover with original screws or fasteners.*
- *Do not access the inside of the power supply. There are no serviceable parts in the power supply. Return to manufacturer for servicing.*
- *Power down the server and disconnect all power cords before adding or replacing any non hot-plug component.*
- *When replacing a hot-plug power supply, unplug the power cord to the power supply being replaced before removing the power supply from the server.*

Caution: *If the server has been running, any installed processor(s) and heat sink(s) may be hot.*

Unless you are adding or removing a hot-plug component, allow the system to cool before opening the covers. To avoid the possibility of coming into contact with hot component(s) during a hot-plug installation, be careful when removing or installing the hot-plug component(s).

Caution: *To avoid injury do not contact moving fan blades. If your system is supplied with a guard over the fan, do not operate the system without the fan guard in place.*

Rack Mount Warnings

Note: *The following installation guidelines are required by UL for maintaining safety compliance when installing your system into a rack.*

The equipment rack must be anchored to an unmovable support to prevent it from tipping when a server or piece of equipment is extended from it. The equipment rack must be installed according to the rack manufacturer's instructions.

Install equipment in the rack from the bottom up, with the heaviest equipment at the bottom of the rack.

Extend only one piece of equipment from the rack at a time.

You are responsible for installing a main power disconnect for the entire rack unit. This main disconnect must be readily accessible, and it must be labeled as controlling power to the entire unit, not just to the server(s).

To avoid risk of potential electric shock, a proper safety ground must be implemented for the rack and each piece of equipment installed in it.

Elevated Operating Ambient - If installed in a closed or multi-unit rack assembly, the operating ambient temperature of the rack environment may be greater than room ambient. Therefore, consideration should be given to installing the equipment in an environment compatible with the maximum ambient temperature (T_{ma}) specified by the manufacturer.

Reduced Air Flow - Installation of the equipment in a rack should be such that the amount of air flow required for safe operation of the equipment is not compromised.

Mechanical Loading - Mounting of the equipment in the rack should be such that a hazardous condition is not achieved due to uneven mechanical loading.

Circuit Overloading - Consideration should be given to the connection of the equipment to the supply circuit and the effect that overloading of the circuits might have on overcurrent protection and supply wiring. Appropriate consideration of equipment nameplate ratings should be used when addressing this concern.

Reliable Earthing - Reliable earthing of rack-mounted equipment should be maintained.

Particular attention should be given to supply connections other than direct connections to the branch circuit (e.g. use of power strips).

Electrostatic Discharge (ESD)

Caution: *ESD can damage drives, boards, and other parts. We recommend that you perform all procedures at an ESD workstation. If one is not available, provide some ESD protection by wearing an antistatic wrist strap attached to chassis ground -- any unpainted metal surface -- on your server when handling parts.*

Always handle boards carefully. They can be extremely sensitive to ESD. Hold boards only by their edges. After removing a board from its protective wrapper or from the server, place the board component side up on a grounded, static free surface. Use a conductive foam pad if available but not the board wrapper. Do not slide board over any surface.

Other Hazards

Battery Replacement

Caution: *There is the danger of explosion if the battery is incorrectly replaced. When replacing the battery, use only the battery recommended by the equipment manufacturer.*

Dispose of batteries according to local ordinances and regulations.

Do not attempt to recharge a battery.

Do not attempt to disassemble, puncture, or otherwise damage a battery.

Cooling and Airflow

Caution: Carefully route cables as directed to minimize airflow blockage and cooling problems. For proper cooling and airflow, operate the system only with the chassis covers installed. Operating the system without the covers in place can damage system parts. To install the covers:



- Check first to make sure you have not left loose tools or parts inside the system.
- Check that cables, add-in cards, and other components are properly installed.
- Attach the covers to the chassis according to the product instructions.



Laser Peripherals or Devices

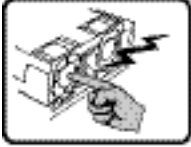
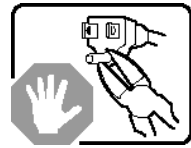
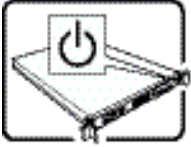

Caution: To avoid risk of radiation exposure and / or personal injury:

- Do not open the enclosure of any laser peripheral or device
- Laser peripherals or devices have are not serviceable
- Return to manufacturer for servicing

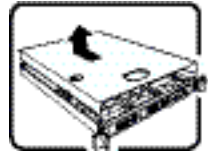
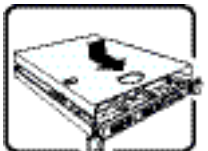
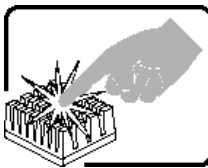
Use certified Optical Fiber Transceiver Class I Laser Product

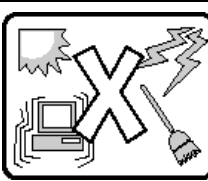
	The power supply in this product contains no user-serviceable parts. Refer servicing only to qualified personnel.
	Do not attempt to modify or use the supplied AC power cord if it is not the exact type required. A product with more than one power supply will have a separate AC power cord for each supply.
	The power button on the system does not turn off system AC power. To remove AC power from the system, you must unplug each AC power cord from the wall outlet or power supply. The power cord(s) is considered the disconnect device to the main (AC) power. The socket outlet that the system plugs into shall be installed near the equipment and shall be easily accessible.
	SAFETY STEPS: Whenever you remove the chassis covers to access the inside of the system, follow these steps: <ol style="list-style-type: none">1. Turn off all peripheral devices connected to the system.2. Turn off the system by pressing the power button.3. Unplug all AC power cords from the system or from wall outlets.4. Label and disconnect all cables connected to I/O connectors or ports on the back of the system.5. Provide some electrostatic discharge (ESD) protection by wearing an antistatic wrist strap attached to chassis ground of the system-any unpainted metal surface-when handling components.6. Do not operate the system with the chassis covers removed.









	<p>After you have completed the six SAFETY steps above, you can remove the system covers. To do this:</p> <ol style="list-style-type: none"> 1. Unlock and remove the padlock from the back of the system if a padlock has been installed. 2. Remove and save all screws from the covers. 3. Remove the cover(s).
	<p>For proper cooling and airflow, always reinstall the chassis covers before turning on the system. Operating the system without the covers in place can damage system parts. To install the covers:</p> <ol style="list-style-type: none"> 1. Check first to make sure you have not left loose tools or parts inside the system. 2. Check that cables, add-in cards, and other components are properly installed. 3. Attach the covers to the chassis with the screws removed earlier, and tighten them firmly. 4. Insert and lock the padlock to the system to prevent unauthorized access inside the system. 5. Connect all external cables and the AC power cord(s) to the system.
	<p>A microprocessor and heat sink may be hot if the system has been running. Also, there may be sharp pins and edges on some board and chassis parts. Contact should be made with care. Consider wearing protective gloves.</p>
	<p>Danger of explosion if the battery is incorrectly replaced. Replace only with the same or equivalent type recommended by the equipment manufacturer. Dispose of used batteries according to manufacturer's instructions.</p>
	<p>The system is designed to operate in a typical office environment. Choose a site that is:</p> <ul style="list-style-type: none"> • Clean and free of airborne particles (other than normal room dust). • Well ventilated and away from sources of heat including direct sunlight. • Away from sources of vibration or physical shock. • Isolated from strong electromagnetic fields produced by electrical devices. • In regions that are susceptible to electrical storms, we recommend you plug your system into a surge suppressor and disconnect telecommunication lines to your modem during an electrical storm. • Provided with a properly grounded wall outlet. • Provided with sufficient space to access the power supply cord(s), because they serve as the product's main power disconnect.

	The rail racks are designed to carry only the weight of the server system. Do not use rail-mounted equipment as a workspace. Do not place additional load onto any rail-mounted equipment.
	Heavy object. Indicates four or more people are required to safely handle the system.

Product Regulatory Compliance Markings

This product is marked with the following Product Certification Markings:

Product Regulatory Compliance Markings

Regulatory Compliance	Region	Marking
cULus Listing Mark	USA / Canada	
CE Mark	Europe	
FCC Marking (Class A)	USA	This device complies with Part 15 of the FCC Rules. Operation of this device is subject to the following two conditions: (1) This device may not cause harmful interference, and (2) This device must accept any interference received, including interference that may cause undesired operation.
ICES	Canada	CAN ICES-3 (A)/NMB-3(A)
VCCI Marking (Class A)	Japan	この装置は、クラス A 情報技術装置です。この装置を家庭環境で使用すると電波妨害を引き起こすことがあります。この場合には使用者が適切な対策を講ずるよう要求されることがあります。 VCCI-A
BSMI Certification Number & Class A Warning	Taiwan	 警告使用者： 此為甲類資訊技術設備，於居住環境使用中時，可能會造成射頻擾動，在此種情況下，使用者會被要求採取某些適當的對策。
EAC Marking	Russia	
Recycling Package Mark	Other than China	
MSIP	Korea	 A급 기기 (업무용 정보통신기기) 이 기기는 업무용으로 전자파적합등록을 한 기기이오니 판매자 또는 사용자는 이 점을 주의하시기 바라며, 만약 잘못판매 또는 구입하였을 때에는 가정용으로 교환하시기 바랍니다.
RCM	Australia	
CCC	China	 此为 A 级产品，在生活环境中，该产品可能会造成无线电干扰。在这种情况下，可能需要用户对其干扰采取切实可行的措施。

Electromagnetic Compatibility Notices

FCC Verification Statement (USA)

This device complies with Part 15 of the FCC Rules. Operation is subject to the following two conditions: (1) this device may not cause harmful interference, and (2) this device must accept any interference received, including interference that may cause undesired operation.

This equipment has been tested and found to comply with the limits for a Class A digital device, pursuant to part 15 of the FCC Rules. These limits are designed to provide reasonable protection against harmful interference when the equipment is operated in a commercial environment. This equipment generates, uses, and can radiate radio frequency energy and, if not installed and used in accordance with the instruction manual, may cause harmful interference to radio communications. Operation of this equipment in a residential area is likely to cause harmful interference in which case the user will be required to correct the interference at his own expense.

Europe (CE Declaration of Conformity)

This product has been tested in accordance too, and complies with the Low voltage Directive (2006/95/EC) and EMC Directive (2004/108/EC). The product has been marked with the CE Mark to illustrate its compliance.

VCCI (Japan)

この装置は、クラス A 情報技術装置です。この装置を家庭環境で使用すると電波妨害を引き起こすことがあります。この場合には使用者が適切な対策を講ずるよう要求されることがあります。

VCCI-A

English translation of the notice above:

This is a Class A product based on the standard of the Voluntary Control Council for Interference (VCCI) from Information Technology Equipment. If this is used near a radio or television receiver in a domestic environment, it may cause radio interference. Install and use the equipment according to the instruction manual.

BSMI (Taiwan)

The BSMI Certification Marking and EMC warning is located on the outside rear area of the product.

警告使用者：

此為甲類資訊技術設備，於居住環境中使用時，可能會造成射頻擾動，在此種情況下，使用者會被要求採取某些適當的對策。

MSIP (Korea)

Ministry of Science, ICT & Future Planning (MSIP) Class A Statement:

A 급 기기(업무용 정보통신기기)
이 기기는 업무용으로 전자파적합등록을 한 기기이오니 판매자 또는 사용자는 이 점을 주의하시기 바라며,
만약 잘못 판매 또는 구입하였을 때에는 가정용으로 교환하시기 바랍니다.

English translation of the notice above:

“A” class equipment (info / technology equipment for business purpose)

As this equipment has undergone EMC registration for business purpose, the seller and/or the buyer is asked to beware of this point and in case a wrongful sale or purchase has been made, it is asked that a change to household use be made.

Regulated Specified Components

To maintain the UL listing and compliance to other regulatory certifications and/or declarations, the following regulated components must be used and conditions adhered to. Interchanging or use of other component will void the UL listing and other product certifications and approvals.

Updated product information for configurations can be found on the site at the following URL:

www.QuantaQCT.com

If you do not have access to the Web address, please contact your local representative.

- **Add-in cards:** must have a printed wiring board flammability rating of minimum UL94V-1. Add-in cards containing external power connectors and/or lithium batteries must be UL recognized or UL listed. Any add-in card containing modem telecommunication circuitry must be UL listed. In addition, the modem must have the appropriate telecommunications, safety, and EMC approvals for the region in which it is sold.
- **Peripheral Storage Devices:** must be UL recognized or UL listed accessory and TUV or VDE licensed. Maximum power rating of any one device is 19 watts. Total server configuration is not to exceed the maximum loading conditions of the power supply.

Restriction of Hazardous Substances (RoHS) Compliance

Quanta® Computer Inc. has a system in place to restrict the use of banned substances in accordance with the European Directive 2011/65/EU. Compliance is based on declaration that materials banned in the RoHS Directive are either (1) below all applicable threshold limits or (2) an approved / pending RoHS exemption applies.

RoHS implementation details are not fully defined and may change.

Threshold limits and banned substances are noted below:

- Quantity limit of 0.1% by mass (1000 PPM) for:
 - Lead
 - Mercury
 - Hexavalent Chromium
 - Polybrominated Diphenyl Ethers (PBDE)
- Quantity limit of 0.01% by mass (100 PPM) for:
 - Cadmium

End of Life / Product Recycling

Product recycling and end-of-life take-back systems and requirements vary by country. Contact the retailer or distributor of this product for information about product recycling and / or take-back.

設備名稱： 伺服器 ，型號（型式）：D52B-1U

單元 Unit	限用物質及其化學符號					
	鉛Lead (Pb)	汞Mercury (Hg)	鎘Cadmium (Cd)	六價鉻 Hexavalent chromium (Cr ⁺⁶)	多溴聯苯 Polybrominated biphenyls (PBB)	多溴二苯醚 Polybrominated diphenyl ethers (PBDE)
金屬機殼	○	○	○	○	○	○
電路板	○	○	○	○	○	○
塑膠面板	○	○	○	○	○	○
金屬滑軌	○	○	○	○	○	○
電源線/連接線	○	○	○	○	○	○
散熱模組	○	○	○	○	○	○

備考1. “超出0.1 wt %” 及 “超出0.01 wt %” 係指限用物質之百分比含量超出百分比含量基準值

備考2. “○” 係指該項限用物質之百分比含量未超出百分比含量基準值。

備考3. “—” 係指該項限用物質為排除項目。